

Maattabellen flensdichtingen

- mit und ohne Dichtleiste IBC
- mit Vor und Rücksprung SR
- mit Nut und Feder TG
- mit Schraubenlöchern FF

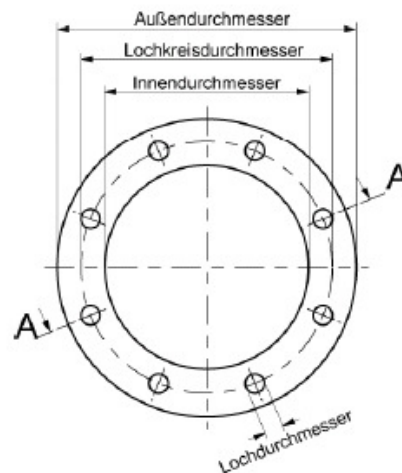

Flansch - / Dichtungsformen:

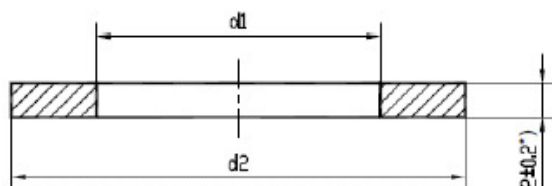
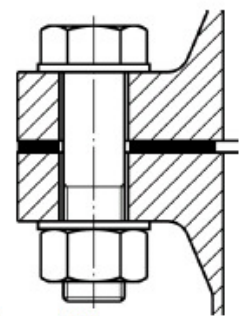
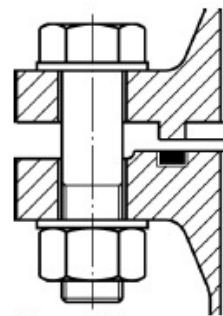
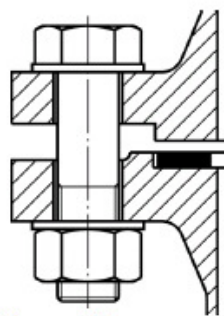
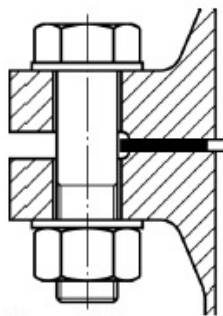

Profilbeispiele:

FD 01



ohne Bördel

FD 04



FD 10



mit Innenbördel

FD 11



FD 30



mit Doppelbördel

FD 33



*) Standarddicke

Maattabellen flensdichtingen RF DIN EN1514-1

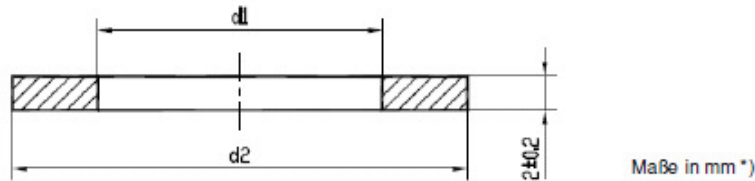

Flanschform		IBC							SR ¹⁾	TG ¹⁾		
Nenndruck		PN 2,5	PN 6	PN 10	PN 16	PN 25	PN 40	PN 63 ⁴⁾	PN 10 - 40 (160)			
DN	d1 mm	d2 mm					d1 ⁵⁾ mm	d2 mm	d2 mm	d1 mm	d2 mm	
10	18	39		46			18	56	34	24	34	
15	22	44		51			21	61	39	29	39	
20	27	54		61			25	72	50	36	50	
25	34	64		71			30	82	57	43	57	
32	43	76		82			41	88	65	51	65	
40	49	86		92			47	103	75	61	75	
50	61	96		107			59	113	87	73	87	
60 ³⁾	72	106		117			68	123	-	-	-	
65	77	116		127			73	138	109	95	109	
80 ²⁾	92	132		142			86	148	120	106	120	
100	115	152		162		168		110	174	149	129	149
125	141	182		192		194		135	210	175	155	175
150	169	207		218		224		163	247	203	183	203
200	220	262		273		284	290	210	309	259	239	259
250	273	317		328		340	352	264	364	312	292	312
300	324	373		378	384	400	417	314	424	363	343	363
350	356	423		438	444	457	474	360	486	421	395	421
400	407	473		489	495	514	546	415	543	473	447	473
450	458	528		539	555	564	571	-	-	523	497	523
500	508	578		594	617	624	628	-	-	575	549	575
600	610	679		695	734	731	747	-	-	675	649	675
700	712	784		810	804	833	-	-	-	777	751	777
800	813	890		917	911	942	-	-	-	882	856	882
900	915	990		1017	1011	1042	-	-	-	987	961	987
1000	1016	1090		1124	1128	1154	-	-	-	1092	1062	1092
1100	1120	-	-	1231	1228	1254	-	-	-	1292	1262	1292
1200	1220	1290	1307	1341	1342	1364	-	-	-	1492	1462	1492
1400	1420	1490	1524	1548	1542	1578	-	-	-	1692	1662	1692
1500 ³⁾	1520	-	-	1658	1654	1688	-	-	-	1892	1862	1892
1600	1620	1700	1724	1772	1764	1798	-	-	-	2092	2062	2092
1800	1820	1900	1931	1972	1964	2000	-	-	-	-	-	-
2000	2020	2100	2138	2182	2168	2230	-	-	-	-	-	-
2200	2220	2307	2348	2384	-	-	-	-	-	-	-	-
2400	2420	2507	2558	2594	-	-	-	-	-	-	-	-
2600	2620	2707	2762	2794	-	-	-	-	-	-	-	-
2800	2820	2924	2972	3014	-	-	-	-	-	-	-	-
3000	3020	3124	3172	3228	*)Toleranzen nach DIN ISO 2768 Toleranzklasse V 1) Abmessungen TG / SR > DN1000 nach EN 1092 2) Innendurchmesser abweichend (89mm) von der EN1514-1 3) Nur für Gusseisenflansche 4) PN63 DN175 = 185mm X 277mm 5) Innendurchmesser nur für PN 63 IBC							
3200	3220	3324	3382	-								
3400	3420	3524	3592	-								
3600	3620	3734	3804	-								
3800	3820	3931	-	-								
4000	4020	4131	-	-								

Maattabellen Flensdichtungen FF DIN EN 1514-1

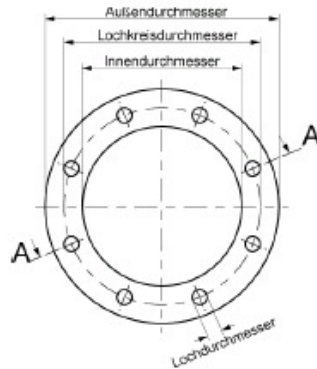

Maße in mm*

DN	d1 mm	PN 2,5 / 6			PN 10			PN 16			PN 25			PN 40			
		d2	Schraubenlöcher		LK Ø	d2	Schraubenlöcher		LK Ø	d2	Schraubenlöcher		LK Ø	d2	Schraubenlöcher		LK Ø
			n	Ø			n	Ø			n	Ø			n	Ø	
10	18	75	4	11	50	90	4	14	60	90	4	14	60	90	4	14	60
15	22	80	4	11	55	95	4	14	65	95	4	14	65	95	4	14	65
20	27	90	4	11	65	105	4	14	75	105	4	14	75	105	4	14	75
25	34	100	4	11	75	115	4	14	85	115	4	14	85	115	4	14	85
32	43	120	4	14	90	140	4	18	100	140	4	18	100	140	4	18	100
40	49	130	4	14	100	150	4	18	110	150	4	18	110	150	4	18	110
50	61	140	4	14	110	165	4	18	125	165	4	18	125	165	4	18	125
60	72	150	4	14	120	175	8	18	135	175	8	18	135	175	8	18	135
65	77	160	4	14	130	185	8	18	145	185	8	18	145	185	8	18	145
80 ¹⁾	92	190	4	18	150	200	8	18	160	200	8	18	160	200	8	18	160
100	115	210	4	18	170	220	8	18	180	220	8	18	180	235	8	22	190
125	141	240	8	18	200	250	8	18	210	250	8	18	210	270	8	26	220
150	169	265	8	18	225	285	8	22	240	285	8	22	240	300	8	26	250
200	220	320	8	18	280	340	8	22	295	340	12	22	295	360	12	26	310
250	273	375	12	18	335	395	12	22	350	405	12	26	355	425	12	30	370
300	324	440	12	22	395	445	12	22	400	460	12	26	410	485	16	30	430
350	356	490	12	22	445	505	16	22	460	520	16	26	470	555	16	33	490
400	407	540	16	22	495	565	16	26	515	580	16	30	525	620	16	36	550
450	458	595	16	22	550	615	20	26	565	640	20	30	585	670	20	36	600
500	508	645	20	22	600	670	20	26	620	715	20	33	650	730	20	36	660
600	610	755	20	26	705	780	20	30	725	840	20	36	770	845	20	39	770
700	712	-	-	-	-	895	24	30	840	910	24	36	840	960	24	42	875
800	813	-	-	-	-	1015	24	33	950	1025	24	39	950	1085	24	48	990
900	915	-	-	-	-	1115	28	33	1050	1125	28	39	1050	1185	28	48	1090
1000	1016	-	-	-	-	1230	28	36	1160	1255	28	42	1170	1320	28	56	1210
1100	1120	-	-	-	-	1340	32	39	1270	1355	32	42	1270	1420	32	56	1310
1200	1220	-	-	-	-	1455	32	39	1380	1485	32	48	1390	1530	32	56	1420
1400	1420	-	-	-	-	1675	36	42	1590	1685	36	48	1590	1755	36	62	1640
1500 ²⁾	1520	-	-	-	-	1785	36	42	1700	1820	36	56	1710	1865	36	62	1750
1600	1620	-	-	-	-	1915	40	48	1820	1930	40	56	1820	1975	40	62	1860
1800	1820	-	-	-	-	2115	44	48	2020	2130	44	56	2020	2195	44	70	2070
2000	2020	-	-	-	-	2325	48	48	2230	2345	48	62	2230	2425	48	70	2300

¹⁾ Innendurchmesser abweichend (89mm) von der EN1514-1

²⁾ Nur für Gusseisenflansche

^{*)} Toleranzen nach DIN ISO 2768 Toleranzklasse V